

Notice de montage

Composteur



Informations sur les composteurs

400 L



800 L



Caractéristiques :

- Les composteurs sont en bois Douglas non traité origine Vosges (certifié PEFC)
- DUME : 26-583-0867
- Garantie de 7 ans (bois et quincaillerie)

Litrage	400L	800L
Emprise au sol	776x776 mm	1006xx1006 mm
Longueur, largeur, hauteur	816x834x761 mm	1046x1053x883 mm
Poids	36 kg	52 kg

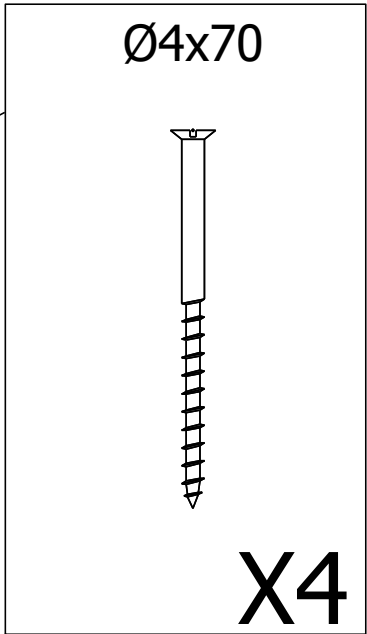
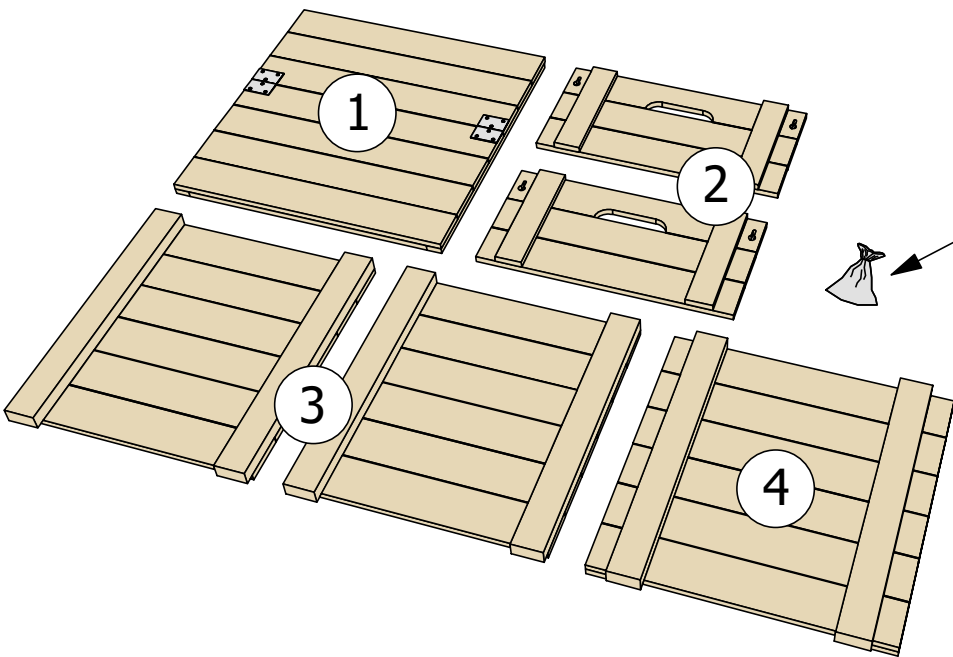
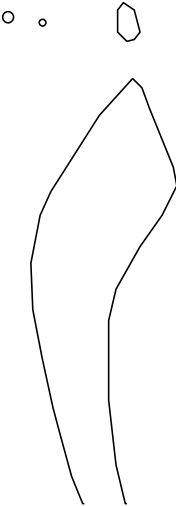
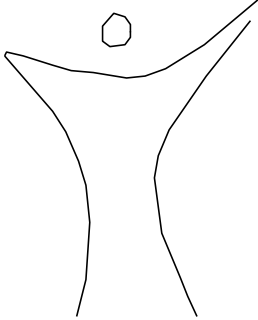

1

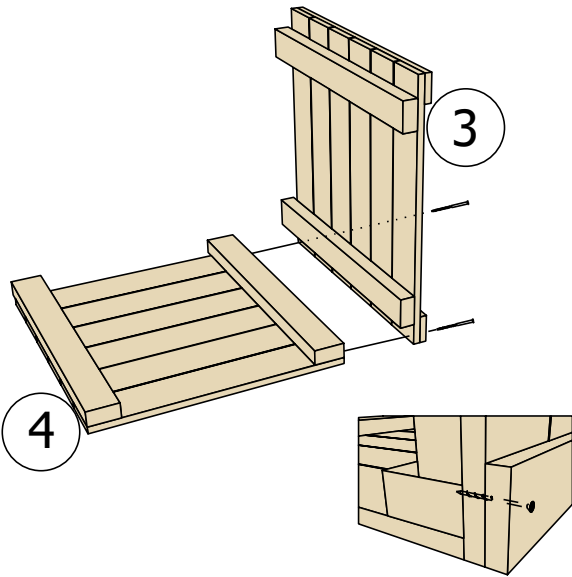

2

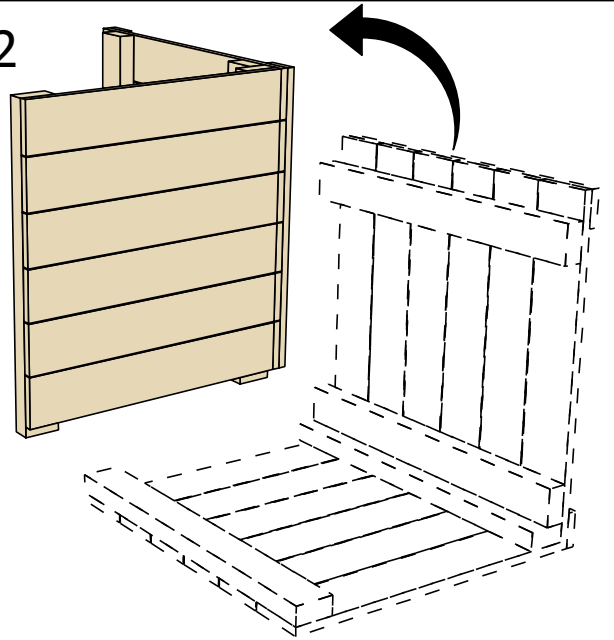

3

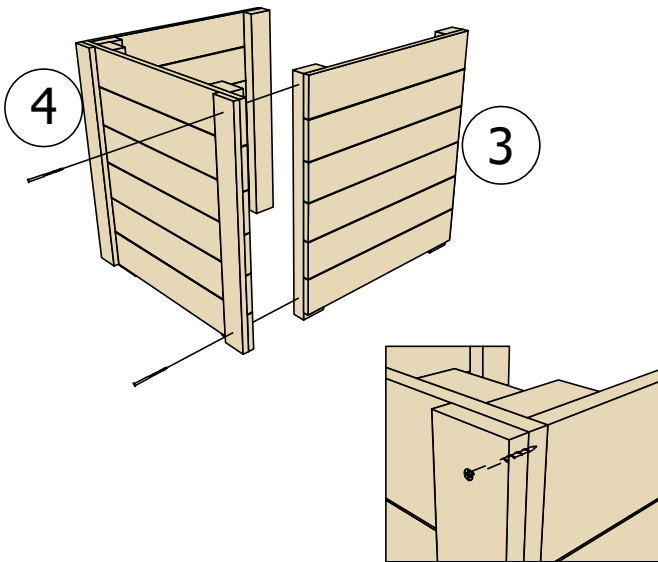

4

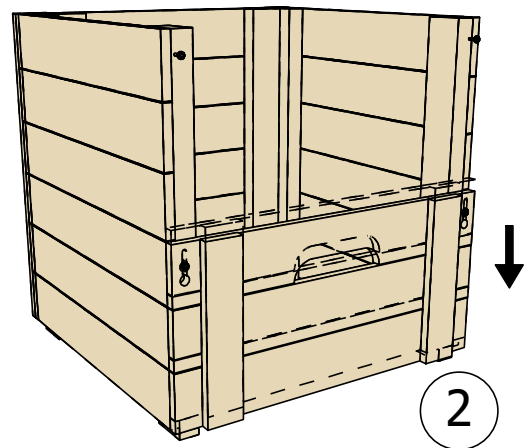

5

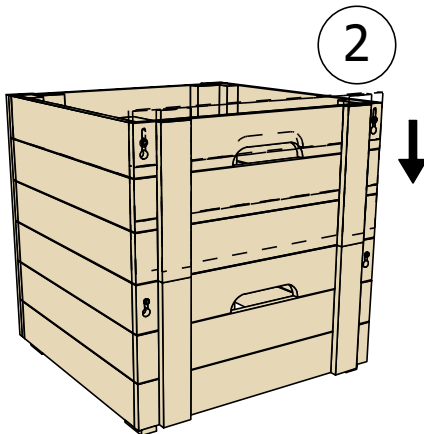

6

